

IRIS 2

cotas piscina (exterior)
côtes piscine (extérieure)
Schwimmbadmasse (äussere)

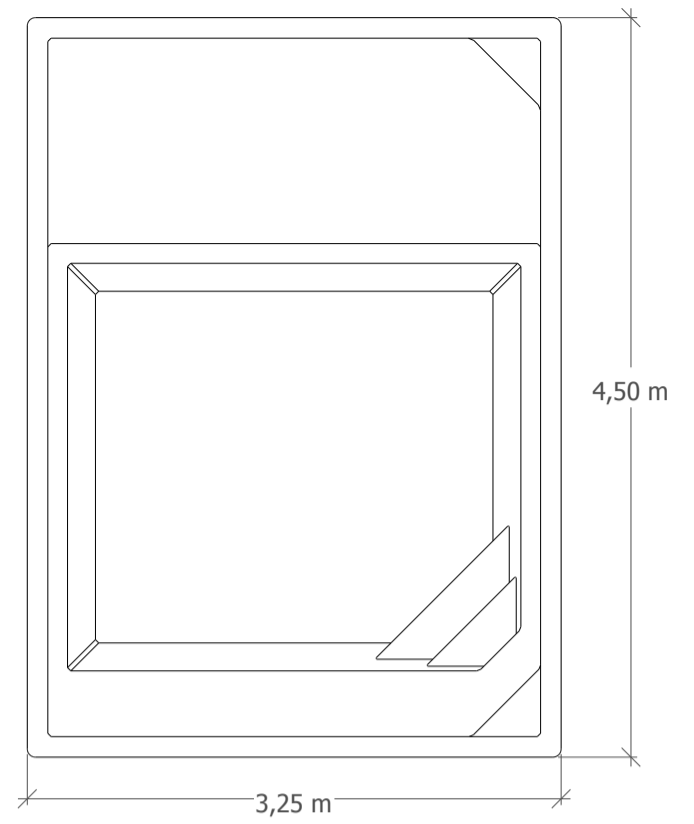

cotas excavación
côtes d'excavation
Aushubmasse

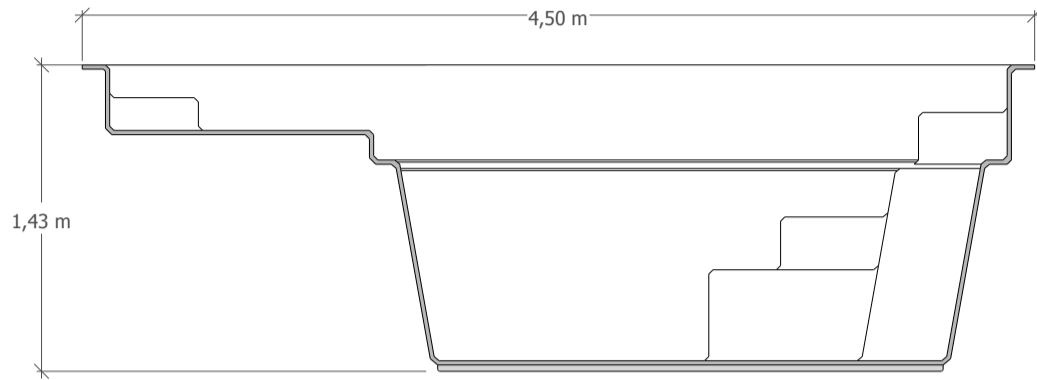
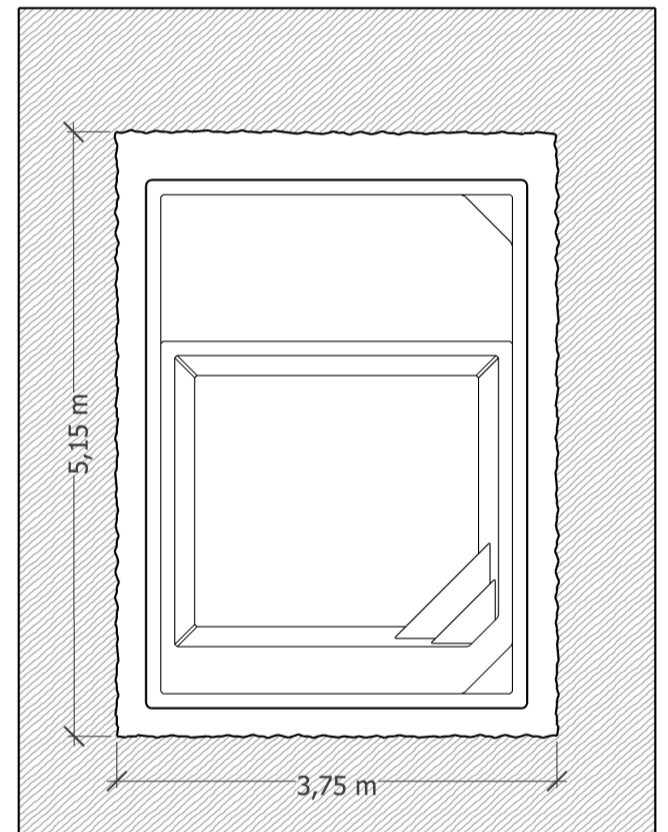
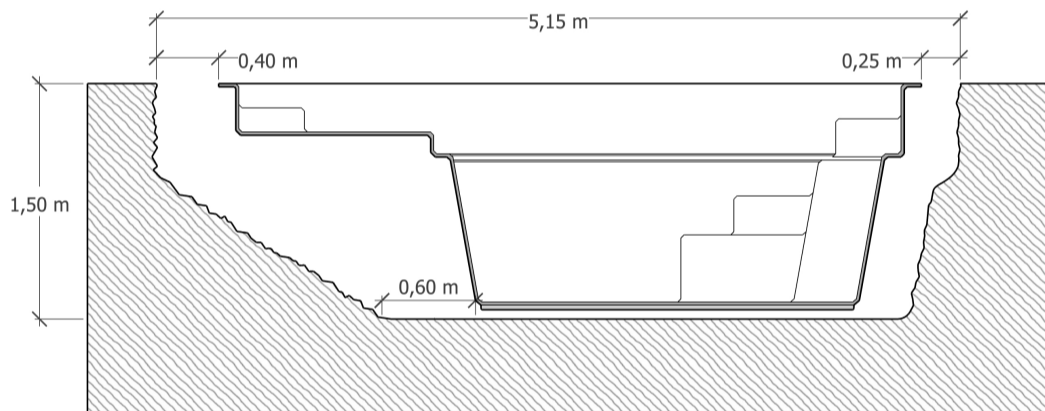

preparación terreno
(regla de base)
préparations du terrain
(règle du base)
Vorbereitung des Bodens
(Faustregel)

