

cotas piscina (exterior)
 côtes piscine (extérieure)
 Schwimmbadmasse (äussere)

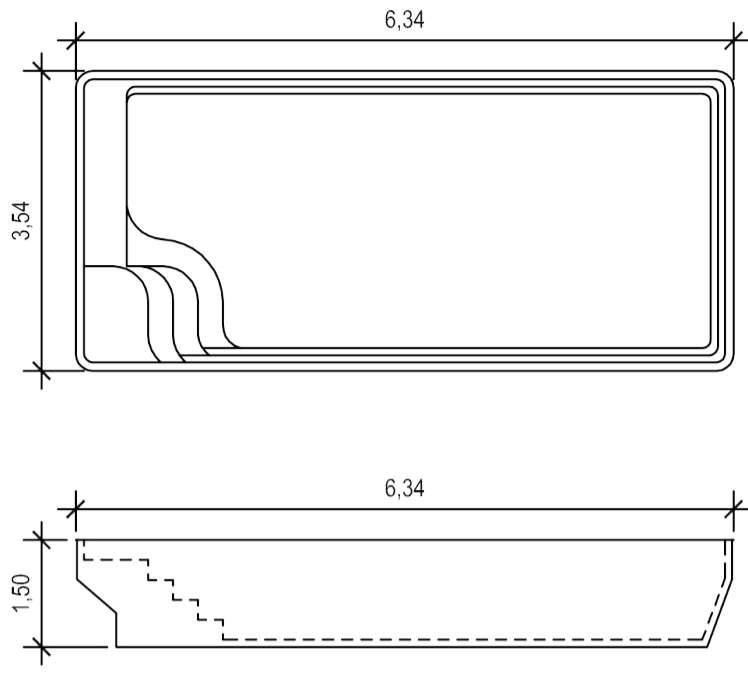

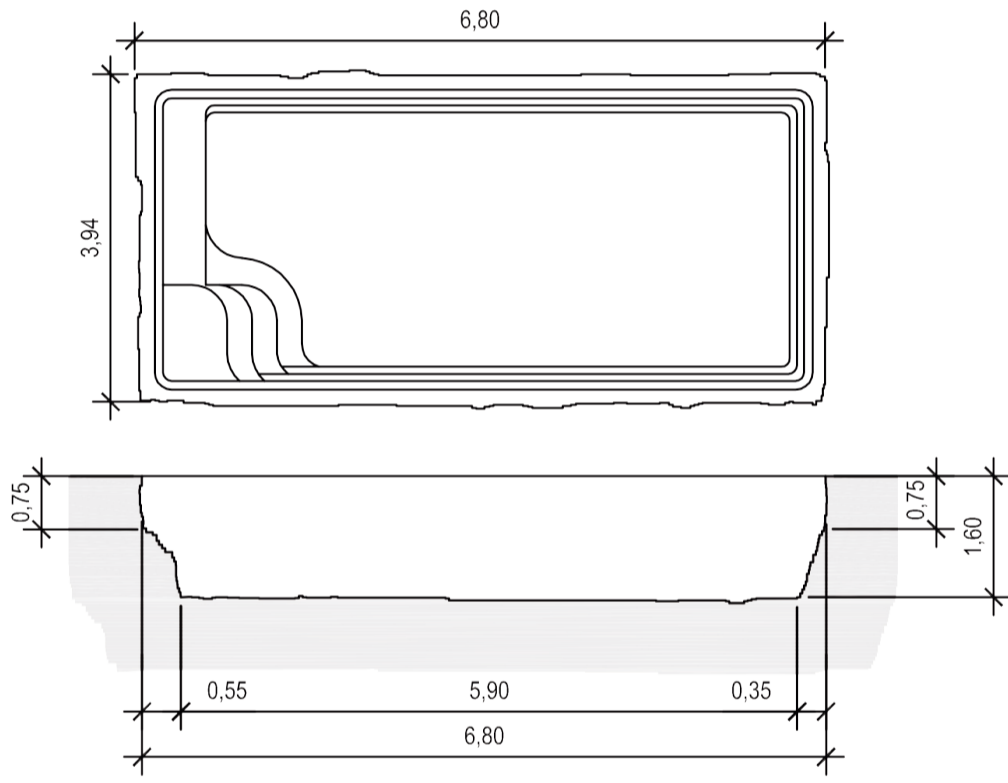

 ceramic de luxe
 - P O O L S -

cotas excavación
 côtes d'excavation
 Aushubmasse

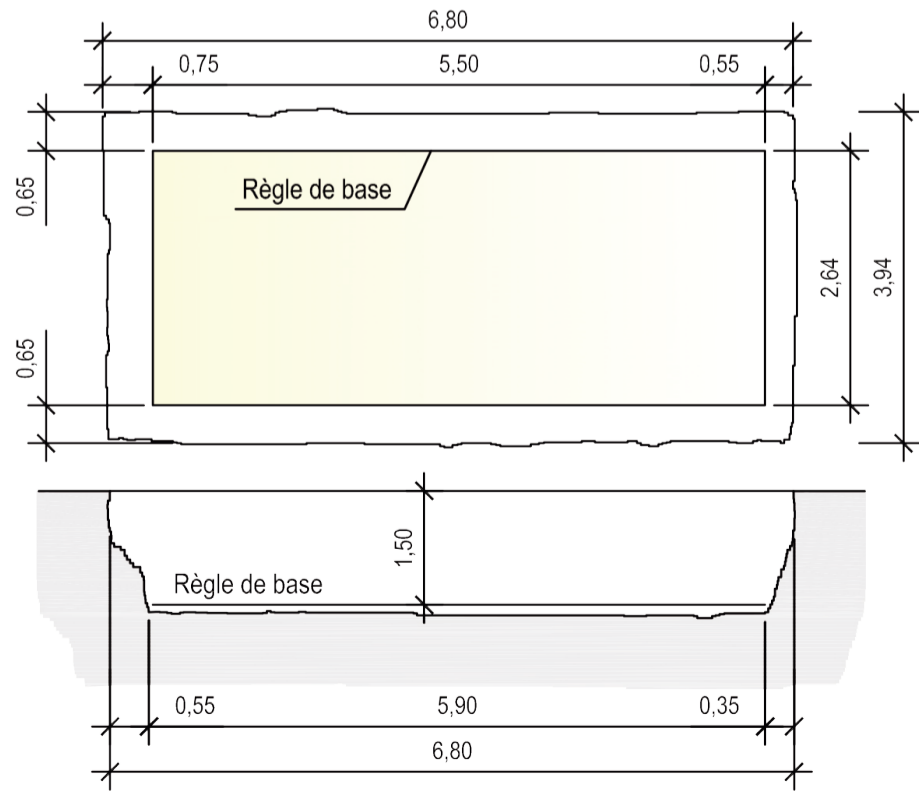

preparación terreno (regla de base)
 préparation du terrain (règle de base)
 Vorbereitung des Bodens (Faustregel)



Nashira 6